

CUTSHEET

Front View

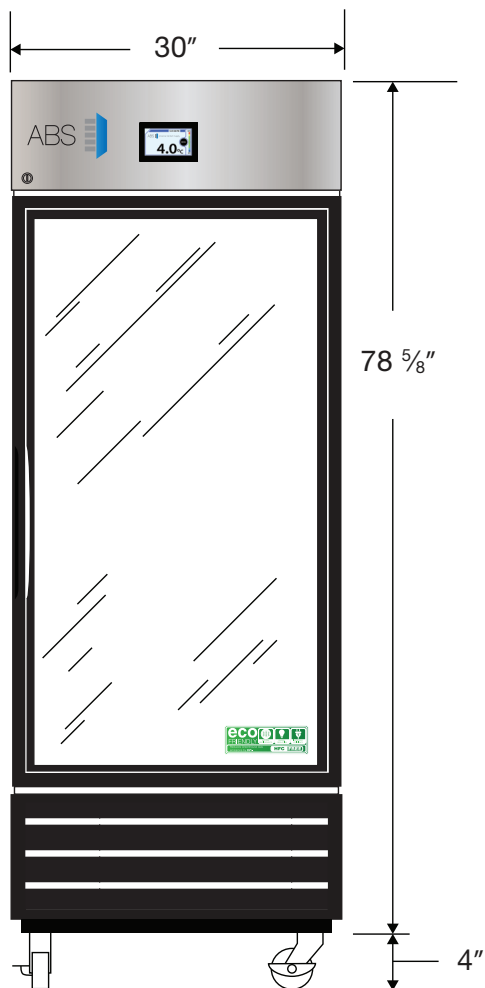

Side View

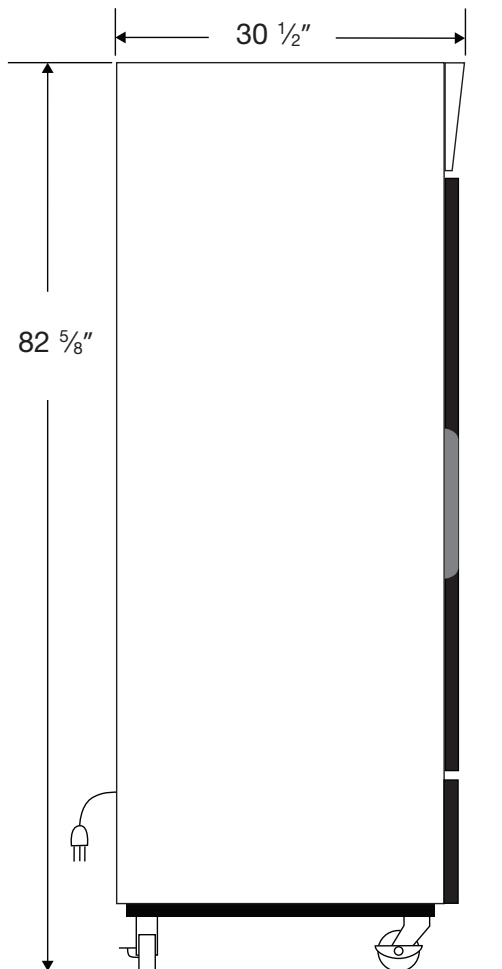

Top View

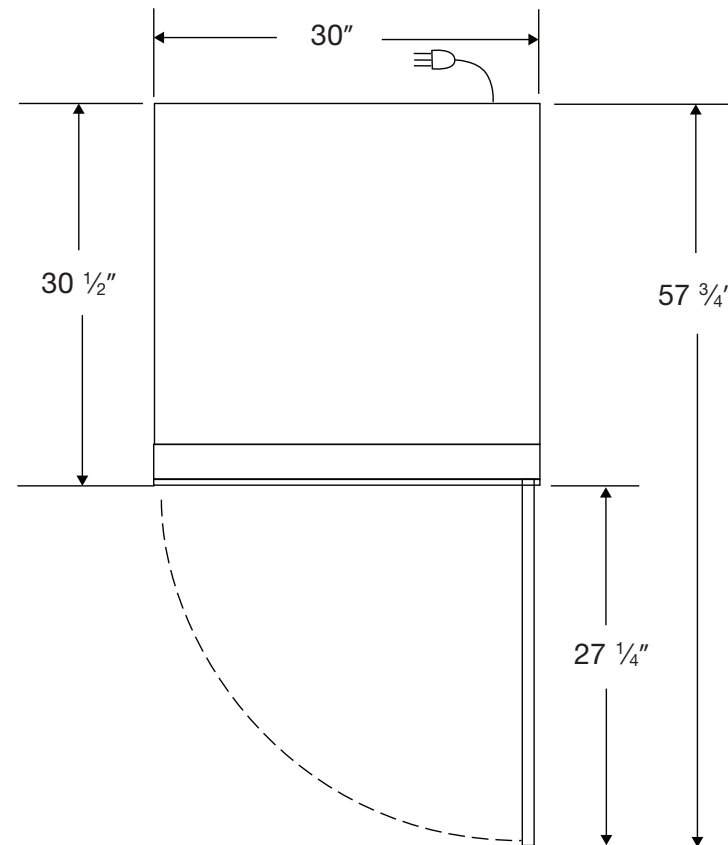

115VAC/60Hz/1PH  
NEMA-5-15P

Cu. Ft	Defrost	Door	Int Door	Shelves	W"	D"	H"	Refrigerant	H.P.	Amps	Weight
26	Cycle	1 Glass	0	4 Adj.	30	30 1/2	82 5/8	R290	1/3	5.4	305 lbs.