

CUTSHEET

Front View

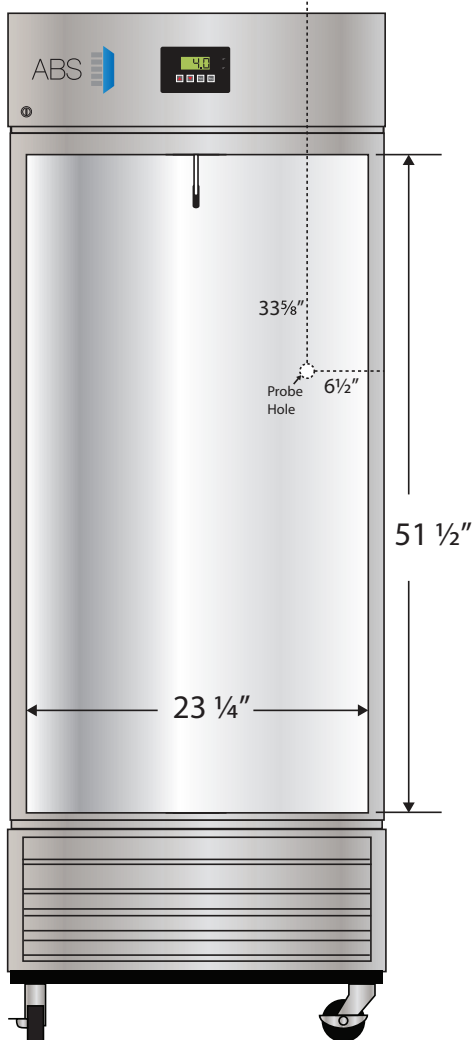

Side View

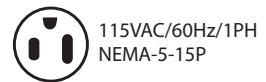
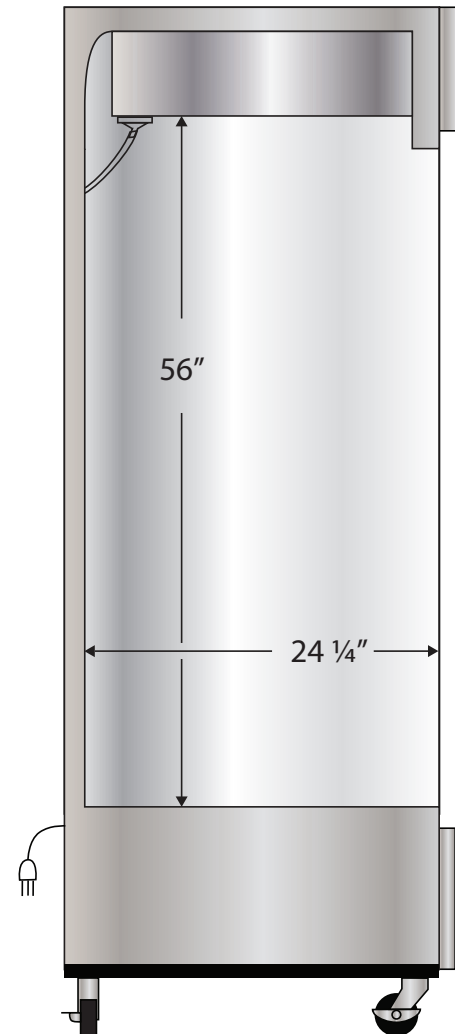

Cu. Ft	Defrost	Door	Int Door	Shelves	Interior Dim.			Refrigerant	H.P.	Amps	Weight
					W"	D"	H"				
23	Cycle	1 Glass	0	3 Adj	23 1/4	24 1/4	56	R290	1/4	2.2	290 lbs.

Note: Interior dimensions are estimates and subject to change without notice