

CUTSHEET

Front View

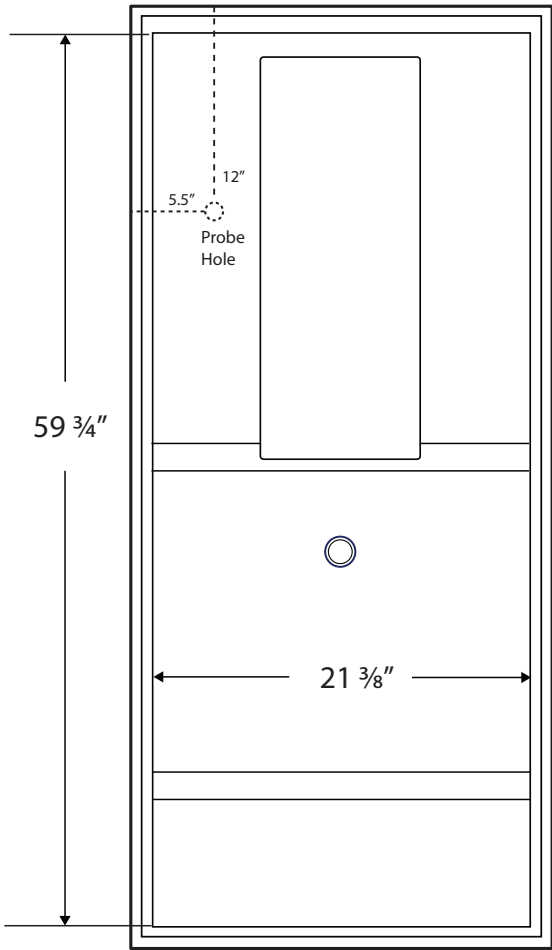

Side View

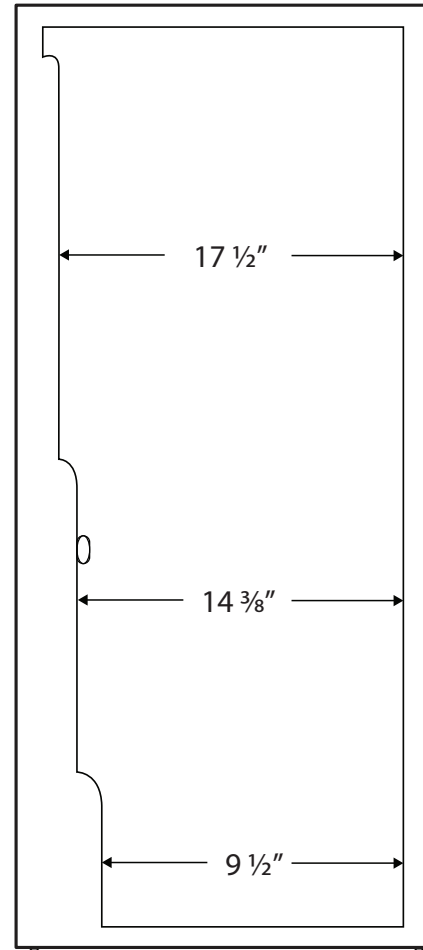

115VAC/60Hz/1PH
NEMA-5-15P

Cu. Ft	Defrost	Door	Int Door	Shelves	Interior Dim.			Refrigerant	H.P.	Amps	Weight
					W"	D"	H"				
17	Auto	1 Solid	0	4 Adj + Basket	21 3/8	17 1/2	59 3/4	R600a	1/4	5	190 lbs.

Note: Interior dimensions are estimates and subject to change without notice