

CUTSHEET

Front View

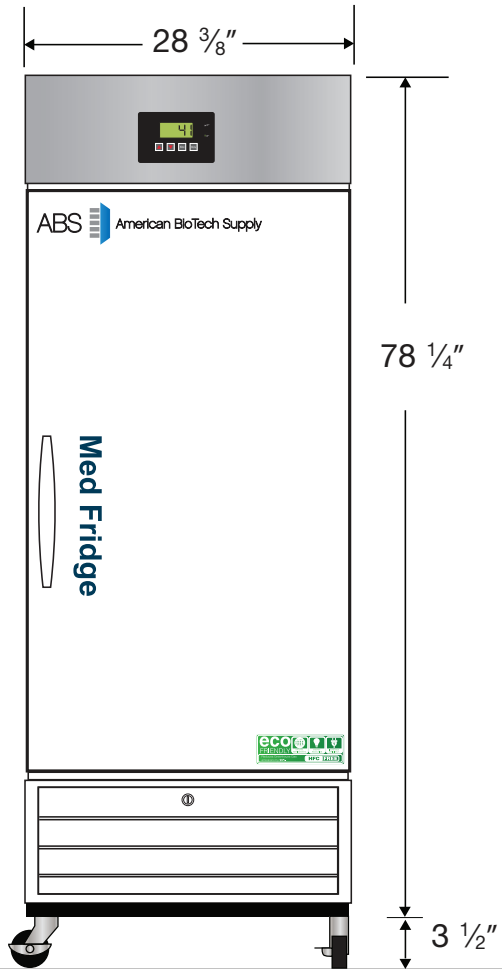

Side View

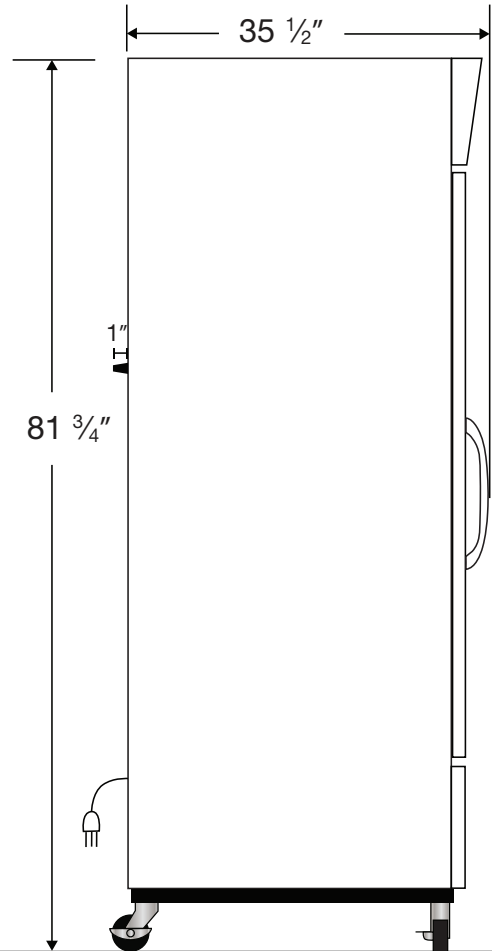

Top View

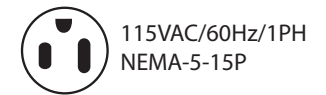
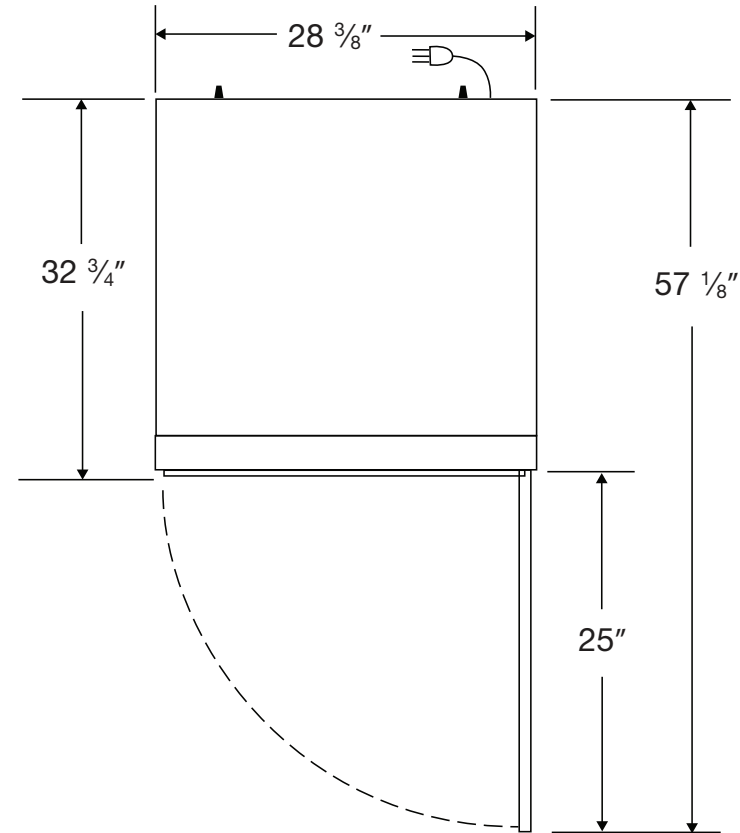

Cu. Ft	Defrost	Door	Int Door	Shelves	W"	D"	H"	Refrigerant	H.P.	Amps	Weight
26	Cycle	1 Solid	0	6 Adj.	28 3/8	36 1/2	81 3/4	R290	1/5	3	235 lbs.