

ABT-HC-SSF-25-LH

Images



Product Description

These 25 cu. ft. freezers are built to last with their durable stainless-steel construction and energy-efficient performance. Designed for laboratories and medical facilities, these units deliver the accuracy and precision you need to support your critical substances.

Experience exceptional microprocessor temperature control and enjoy environmentally friendly refrigerants for energy savings and sustainability. Choose this future-focused freezer to take your lab to the next level of performance.

Certifications



General Description and Application

Storage capacity (cu. ft)	25 Cu. Ft.
Door	One solid, insulated, left hinged, stainless steel
Shelves	Four modular PVC coated wire shelves
Freezer Compartments	Non-applicable
Baskets	Non-Applicable
Mounting	Four, 3.5" Casters, front locking
Interior lighting	6500K LED Strip mounted above door opening
Airflow management	Specialized plenum to improve uniformity
External probe access	3/4" Probe access port
Insulation	Cabinet is foamed-in-place with EPA compliant high density urethane foam
Exterior materials	Ferritic stainless steel exterior
Access Control	Keyed Door Lock
General warranty	Two (2) year parts and labor warranty
Compressor Parts Warranty	Five (5) year compressor parts warranty

Product Weight (lbs)	280
Shipping Weight (lbs)	305
Rated Amperage	7 Amps
Power Plug/Power Cord	NEMA 5-15 Plug, conforms to UL471 requirements
Facility Electrical Requirement	115V, 60 Hz
Agency Listing and Certification	ETL Listed

Refrigeration System

Refrigerant	EPA SNAP compliant, R290
Defrost	Automatic defrost with electric heating element

Controller, Configuration, Alarms and Monitoring

Controller technology	Microprocessor temperature controller
Display technology	Segmented display with LED indicators
External alarm connection	State switching remote alarm contacts
Alarms	Audible and visual high and low temperature alarms, door open
Display Probe	Controller with glass bead media
Adjustable Temperature Range	-25°C to -15°C
Condenser	Tube and fin construction with fan
Evaporator	Tube and fin construction with forced draft cooling system
Disclaimers	Indoor use only, +18C to +26C (+65F to +78F), <70% RH.

Specifications are subject to change.

Auto defrost freezers incorporate an electric heater installed on the evaporator that assist in the removal of the frost and ice. Although the heater helps speed up the frost and ice removal, it can raise the temperatures within the freezer.

Dimensions

	Width (in.)	Depth (in.)	Height (in.)	Door Swing (in.)	Total open Depth (in.)
Exterior	27.625"	32.25"	84.5"	24.375"	56.625"
Interior	23.125"	26.5"	54.5"		

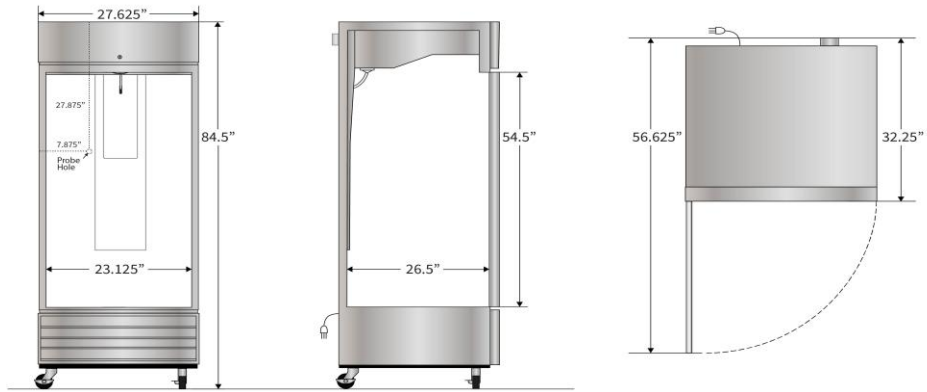

Contact

Customer Service
 Technical Service

800-648-4041 Option 3
 800-648-4041 Option 5, Parts Option 4

customerservice@horizonscientific.com
technicalservice@horizonscientific.com

Rev_03052025