

CUTSHEET

Front View

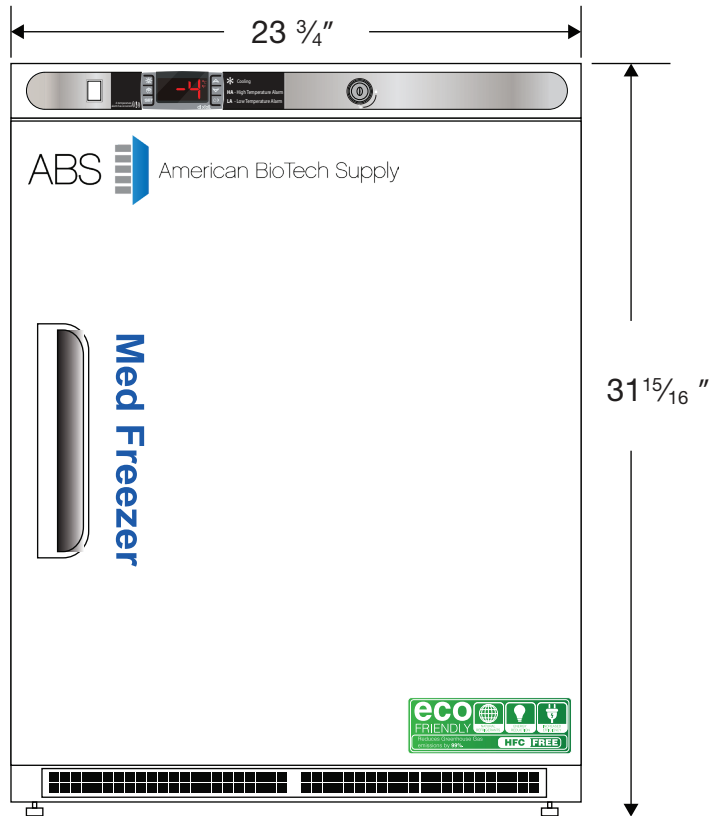

Side View

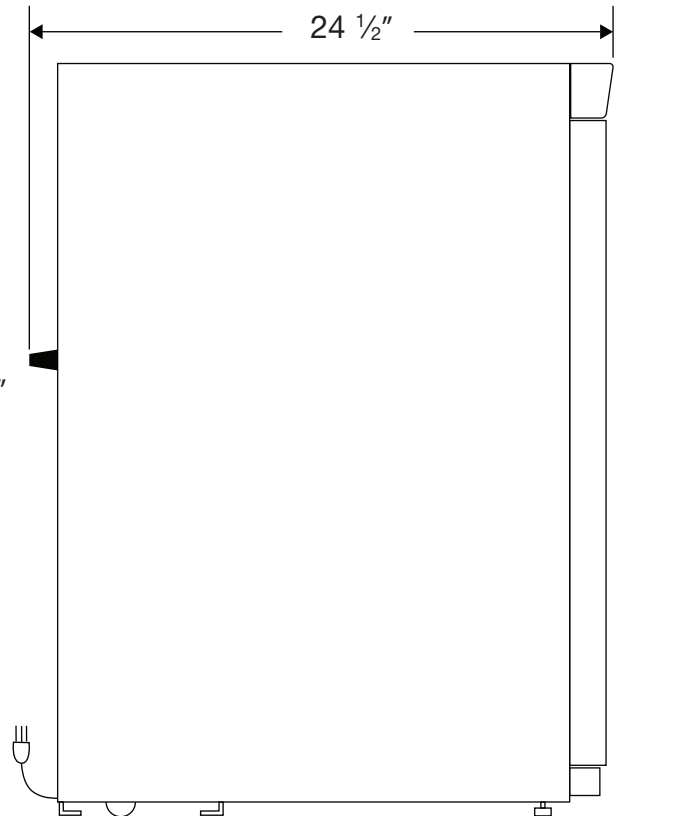

Top View

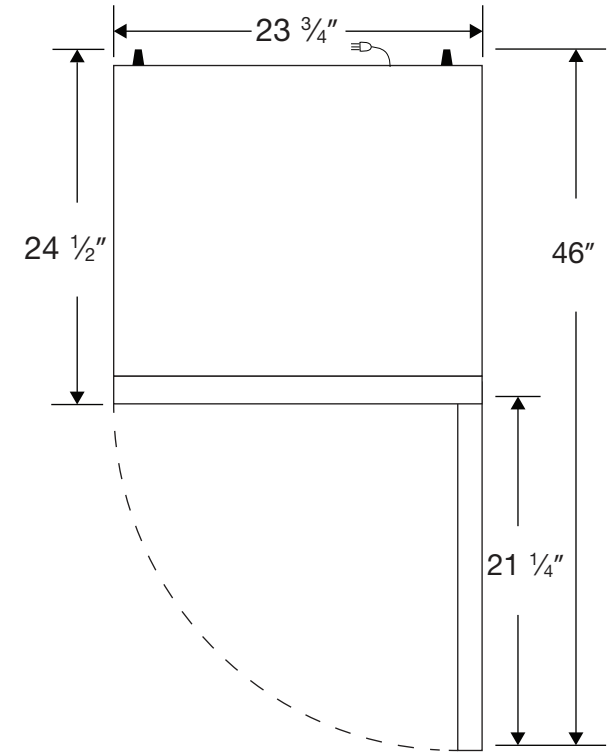

115VAC/60Hz/1PH  
NEMA-5-15P

Cu. Ft	Defrost	Door	Int Door	Shelves	W"	D"	H"	Refrigerant	H.P.	Amps	Weight
4.2	Manual	1 Solid	0	2 Fixed	23 3/4	24 1/2	31 15/16	R600a	1/8	1.5	108 lbs.